

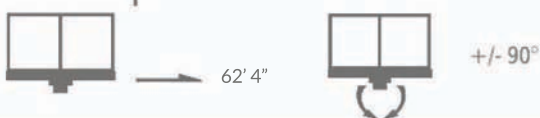

# S41

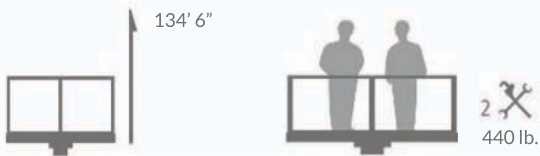

# S41

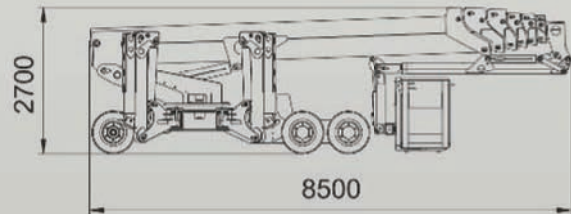
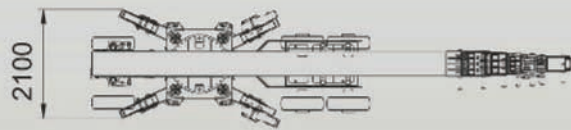
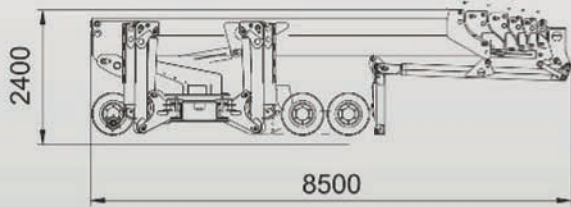

## STABILIZATION



MAX 440 lb.

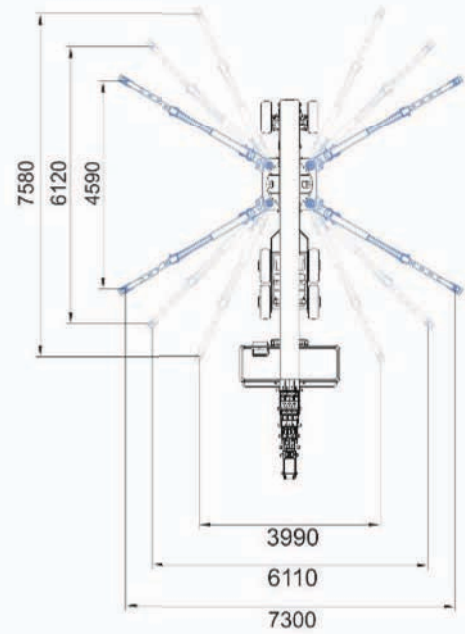
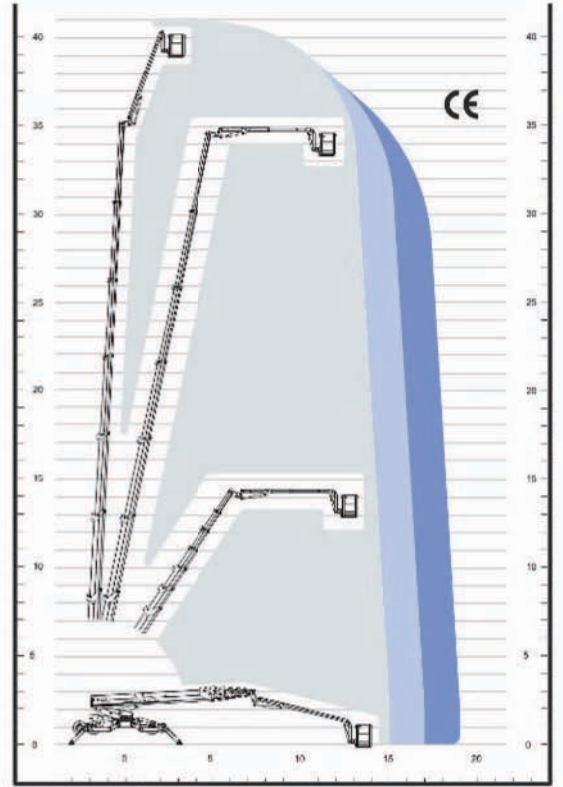

# 135HD

- > 135' Working Height
- > 62' Lateral Reach
- > 441 lbs Basket Capacity
- > 90° Independently Articulating Jib

## UNIQUE FEATURES

- > Simple Reliable Controls
- > Single-Handed Operation
- > Fast Boom Operation
- > Two-Man Aluminum Basket
- > Proportional Basket Controls
- > Hybrid: Kubota Diesel + I20V Plug-In Electric Motor
- > Automatic Outrigger Leveling
- > I20V Electric Outlet In Basket
- > 4 Specialty Outrigger Pads

## OPTIONAL FEATURES

- > Hybrid: Kubota Diesel + Lithium Ion Batteries
- > I2V Emergency Let Down
- > Tires Or Tracks Option
- > Singleman Or Two-Man Fiberglass Basket
- > Non-Marking Rubber Tracks
- > Bright Illumination Light Tower
- > Custom Colors
- > Track Socks



### TECHNICAL SPECIFICATIONS

<b>A</b>	Basket height	44"
<b>B</b>	Basket width	32"
<b>C</b>	Basket length	78"
<b>D</b>	Total length	27' 10"
<b>F</b>	Height in transport position	94"
<b>G</b>	Total width	82"
<b>H</b>	Max. ground clearance	12"
<b>I</b>	Tracks (WxL)	25" x 110"
<b>J</b>	Min. outrigger footprint	13' 1" x 24' 10"
<b>O</b>	Outrigger (stabilizer) plate (foot) diameter	8.7" x 5.5"
	Max. pressure in work	68 lb/ft <sup>2</sup>
	Max pressure in travel	162 lb/ft <sup>2</sup>
	Max. working height	135'
	Max. work outreach	62'
	Max. load on the basket	441 lbs
	Jib movement	90°
	Turret rotation	360° continuous
<b>P</b>	Max. slope to stabilize	3°
<b>W</b>	Max. slope approach angle / slope	7°/12%
<b>X</b>	Gradeability -- max. travel angle / slope	18%
	Maximum travel speed	1.5 mph
	Total weight	29,542 lbs
	Kubota Z602-E3B	17 HP



Specifications and features are subject to change and are not binding.

### 135HD Reach Diagram

= 441 lbs

